

Item	Name	Qty.
1	CA.08.09.14	1
2	GSEG.201490	1

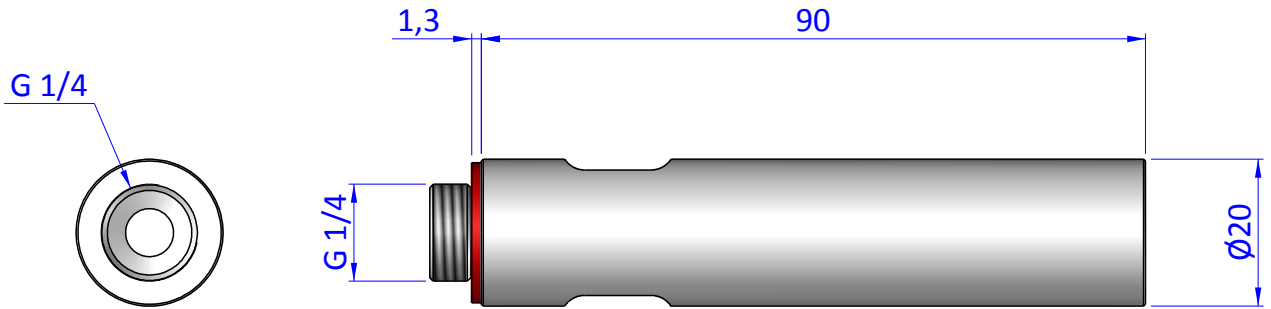
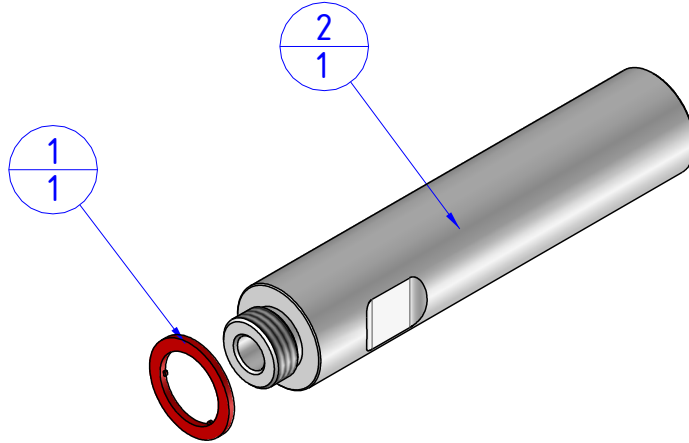

THE PROPERTY OF THE DRAWING IS ESTABLISHED BY LAW. IT IS FORBIDDEN TO PRODUCE OR SHOW IT TO THIRD PART. WITHOUT A WRITTEN AGREEMENT.

Format A4 UNI 936-76					DESIGNED FROM FPSERVICES	REVIEW A
	GENERAL TOLERANCE UNI - ISO 2768 CLASSE f		DESCRIPTION CA.GSEG.201490		DATE 27/02/2019	WEIGHT 0,058kg
					CODE CA.GSEG.201490	